

## Getting Started

This Quick User Guide helps you get started with the **IRIScan™ Anywhere Wifi**. Please read this guide before operating this scanner and its software. All information is subject to change without prior notice.

The software delivered with this scanner is:

- **Readiris™ Pro 14** and **Cardiris™ Pro 5** (for Windows®)
- **Readiris™ Pro 14** and **Cardiris™ Pro 4** (for Mac® OS)

For detailed information about the full range of features of Readiris™ and Cardiris™, consult the **help file** provided with the software, or the latest **User Guides** on [www.irislink.com/support](http://www.irislink.com/support).

## Table of Contents

### Getting Started

1. Introduction
2. Hardware Overview
3. LCD Display
4. Preparing the Scanner
  - 4.1 Charge the Battery
  - 4.2 Insert the microSD Memory Card
5. Using the Scanner
  - 5.1 How to Scan Documents
  - 5.2 Configuring the Settings
  - 5.3 Displaying Scans
  - 5.4 Deleting Files
6. Connecting to a Computer
7. Connecting to the Scanner via Wifi
  - 7.1 Using the Navigation screen (Wifi)
  - 7.2 Using the IRIScan™ App
  - 7.3 Resetting the Wifi Settings
8. Troubleshooting

## **FCC Statement**

Warning: Changes or modifications to this unit not expressly approved by the party responsible for compliance could void the user's authority to operate the equipment.

NOTE: This equipment has been tested and found to comply with the limits for a Class B digital device, pursuant to Part 15 of the FCC Rules. These limits are designed to provide reasonable protection against harmful interference in a residential installation. This equipment generates, uses and can radiate radio frequency energy and, if not installed and used in accordance with the instructions, may cause harmful interference to radio communications.

However, there is no guarantee that interference will not occur in a particular installation. If this equipment does cause harmful interference to radio or television reception, which can be determined by turning the equipment off and on, the user is encouraged to try to correct the interference by one or more of the following measures:

- Reorient or relocate the receiving antenna.
- Increase the separation between the equipment and receiver.
- Connect the equipment into an outlet on a circuit different from that to which the receiver is connected.
- Consult the dealer or an experienced radio/ TV technician for help.

This device complies with Part 15 of the FCC Rules. Operation is subject to the following two conditions:

(1) This device may not cause harmful interference.

(2) This device must accept any interference received, including interference that may cause undesired operation.





## 1. Introduction

The IRIScan™ Anywhere Wifi is designed to be used on its own, disconnected from any computer. The documents you scan are stored on the scanner's microSD card. From there they can be loaded into Readiris™ and Cardiris™, and accessed via Wifi through any Internet browser, and via the IRIScan™ app for iOS and Android.

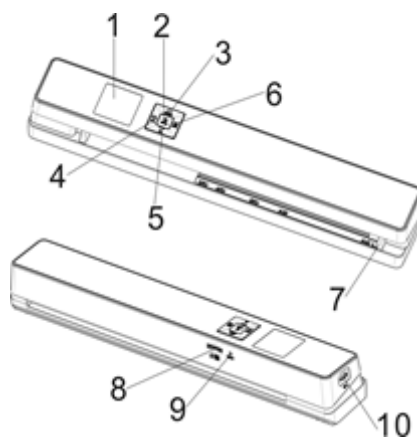
Note that the IRIScan™ Anywhere Wifi is not a Twain-based scanner that can be used from within any application to scan documents. Instead, think of it as an external storage device that is able to scan independently. Via the IRIScan™ app however it can be used to scan directly to your mobile devices.

## 2. Hardware Overview



1	LCD display	Displays the scanning status, scanned image and scanner settings.
2	 ENTER	Press for 3 seconds to power on/off.
3	 JPG/PDF	Press repeatedly to select the file format: JPG, PDF-A4 or PDF-Letter. The corresponding icon is displayed on-screen.
4	 WIFI	Press once to enter Setup mode and configure the settings. and Press for 3 seconds to turn Wifi on/off.
5	 DPI	Press repeatedly to select the scan quality: LO (300dpi), MI (600dpi) or HI (1200dpi). The corresponding icon is displayed on-screen.
6	 BACK	Press to enter Playback mode and display scanned images.
7	Paper guide	Adjust to scan documents of different sizes.

8	microSD card slot	Insert the microSD card in this slot.
9	Reset	Insert paper clip to reset the scanner.
10	USB port	Insert the provided USB cable and connect to a computer to view and transfer files, and to charge the built-in battery. An AC/DC power adapter (not included) can also be used to charge the battery.

### 3. LCD Display

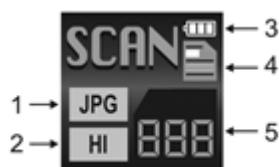

1. Scan Format	JPG, PDF-A, PDF-L
2. Scan Resolution	LO: 300 DPI, MI: 600 DPI, HI: 1200 DPI
3. Battery Power Indicator	Fully charged Low battery. Please recharge.
4. Scan Color	COLOR/MONO
5. File Counter	Shows the number of scans on the microSD card

## 4. Preparing the Scanner

### 4.1 Charge the Battery

Before you can use the IRIScan™ you must first charge the built-in battery:

- Connect the scanner to a computer with the included USB cable.

or

- Connect the scanner to an AC/DC power adapter via USB (Not included).

When the scanner is powered off during charging (recommended), the charge time is about 1.5 hours. When the battery is fully charged, an corresponding icon appears on the screen for a instant.

## 4.2 Insert the microSD Memory Card

---

1. Power OFF the scanner.
2. Insert the microSD card gently into the card slot until the card is latched. The position how the card must be inserted is shown in the image below and on the scanner itself.

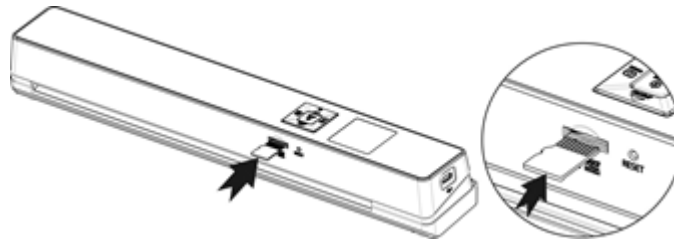

## 5. Using the Scanner

### 5.1 How to Scan Documents

---

1. Press  **ENTER** for 3 seconds to power on the scanner. When you power on the scanner for the first time you need enter the time/date and the display language as explained in 4.2.

**Note:** the scanner auto powers off if it is not used for 10 minutes.

2. Use the paper guides to align the documents with the scanner.
3. Smooth the edges of the document before scanning.
4. Aim the edge of the document at the scanner slot.
5. Gently insert a document facing upwards into the scanner slot. The scanning starts automatically.

**Tip:** align the documents left in the scanner slot.

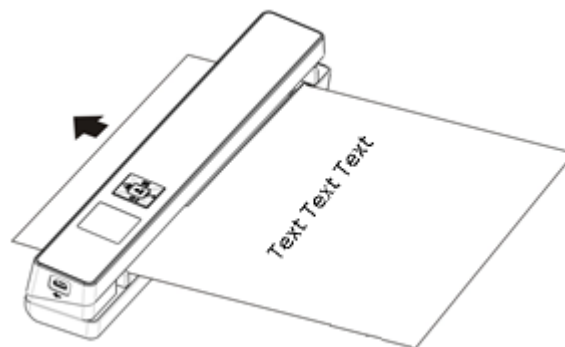

During scanning, the scanning status is displayed on-screen.











**Notes:**

1. When you are scanning while the scanner is connected to an external power supply, the scanner enters battery charging mode if no action is undertaken during 1 minute.
2. If the **Instant Preview** is set to "on", the scanned image is always shortly displayed on-screen before the scanner returns to standby mode.
3. When the memory card is full, the scanner is unable to scan more images and **"Full"** flashes on the screen for 2 seconds.



## 5.2 Configuring the Settings

---

1. Press  to enter Setup menu.
2. Press  or  **JPG/PDF** or **DPI** to flip through the different settings.
3. Press  **ENTER** to enter a setting.
4. Again press  or  **JPG/PDF** or **DPI** to go through the available options.
5. Press  **ENTER** to confirm and to return to the previous screen.
6. To exit Setup Mode or to return to previous screens, press  or  **BACK**.

### Settings Overview

Menu items	Description
JPG/PDF	Scan Format: JPG, PDF-A4, PDF- Letter
Quality	Scan Quality: 300 dpi, 600 dpi, 1200 dpi
Color	Scan Color: Color/Mono
Language	Menu Language
Date/Time	Date and Time
Inst.Preview	Instant Preview
Auto Off	Auto Power Off: disabled or after 10 minutes.
Delete All	Delete All Files
Format	Format the microSD Memory Card
Reset Wifi	Reset the Wifi settings
Device Info	Device Information



## 5.3 Displaying Scans

---

When you have scanned documents, you can display the scans on the scanner screen.

1. Press  **BACK** to enter Playback mode. The last scanned image is displayed.







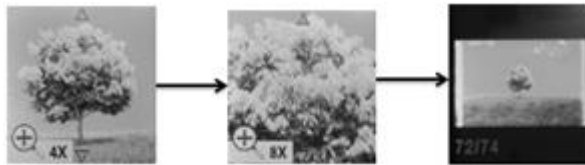





2. Press  **JPG/PDF** or  **DPI** to flip through the scans.

3. To zoom in on a scan, press  **ENTER** once to zoom to 4x, or twice to zoom to 8x.









**Note:** if a scan exceeds 9 MB you cannot zoom in on it.

4. The  and  indicators appear on the screen and allow you to view the different parts of the image. Press  **JPG/PDF** or  **DPI** to move up/down on the image.
5. Press  to make the  and  indicators appear. Press  **JPG/PDF** or  **DPI** to move left/right on the image.
6. Press  **BACK** to return to normal view.

## 5.4 Deleting Files

---

1. Press  **BACK** to enter Playback mode.
2. Press  **JPG/PDF** or  **DPI** to select the file you want to delete.
3. Press .
4. Press  **JPG/PDF** or  **DPI** to select "Yes" or "No".
5. Press  **ENTER** to confirm your selection and return to the previous screen.

## 6. Connecting to a Computer

You can connect your scanner to your computer and view the scans on the computer screen.

1. Press  **ENTER** for 3 seconds to power on the scanner.
2. Connect the scanner to your computer using the USB cable.

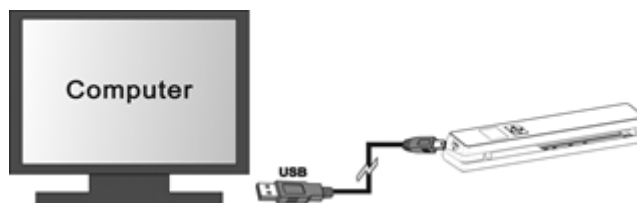

3. Press  **ENTER** briefly to enter USB mode. The USB icon is displayed on the scanner screen, and the scanner is now recognized as removable disk.





4. Browse to **Computer > Removable disk > DCIM\100Media** to view, import, copy, move or delete scans.  
**Note:** on Mac OS the Removable disk icon is displayed on the Desktop.

**Tip:** you can use **Readiris™** and **Cardiris™** to load the scans from the removable disk and convert them into compressed and text-searchable output formats.

For information on how to process your documents with **Readiris™** and **Cardiris™** see their Quick User Guides on the installation DVD-ROM and their complete User Guides on [www.irislink.com/support](http://www.irislink.com/support).

## 7. Connecting to the Scanner via Wifi

### Enable the Wifi Function

1. Press  **ENTER** for 3 seconds to power on the scanner.
2. Press  for 3 seconds.  
**"Starting"** appears on-screen.



3. Wait 30-40 seconds for the Wifi to initialize.  
**"Ready"** appears on-screen once the Wifi mode is enabled and ready for connection.





## Connect to the Scanner

1. Go to the network settings on your computer/smart device and enable its Wifi function.
2. Search for the **IRIScan™** network and connect to it.

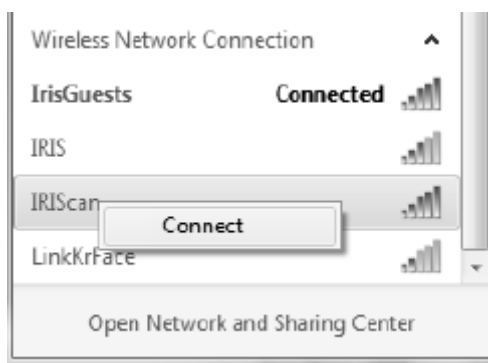

*Example from Windows*

3. When you connect for the first time you are asked for a password. Enter **123456789** as password to connect to the scanner.
4. When the connection is successful, "**Connected**" appears on-screen.



5. Open an Internet browser and enter **192.168.1.2** in the address bar to access the Navigation screen.

### Notes:

1. The use of Wifi consumes more battery power. To preserve battery power, it is recommended to turn the Wifi off when you are not using it. To turn off the Wifi press and hold .
2. In Wifi mode you cannot use the scanner to scan documents, unless you are using the Scan Direct function in the IRIScan™ App. See 7.2 for more info.
3. You cannot calibrate the scanner in Wifi mode. See [www.irislink.com/support](http://www.irislink.com/support) for calibration info.

## 7.1 Using the Navigation screen (Wifi)

---

In the navigation screen all scanned images are displayed as thumbnails. You can view, download and delete files stored on the microSD card the scanner and also change the scanner's Wifi settings.

### Viewing Files

1. Click the **View** button of the file you want to preview. You can preview one file at a time.
2. Click the expand icon to zoom in on the image.



3. Click the X in the bottom right corner to close the preview.

**Note:** if a file in JPG format exceeds 4MB, "**Image is too large**" is displayed and the file cannot be previewed in the Navigation screen. To preview large files you must connect to the scanner via USB cable.



## Deleting Files

1. Click **Delete**.
2. Select the files you want to delete one by one.  
Or click **Select all** in the dialog box.

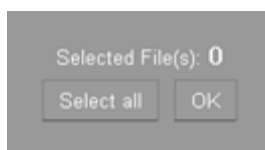

3. Click **OK** to confirm the deletion.

## Changing the Scanner Wifi settings

1. Click **Scanner Wifi settings**.  
**Note:** to access these settings on a small smartphone screen, tap **Menu**. Then tap **Scanner Wifi settings** at the bottom of the screen.
2. Now you can enter a new **Name** and **Password** if you want to.  
The password must be 9 characters long.  
**IMPORTANT:** do *not* change the IP Address or Domain Name.
3. Click **Submit** to submit the new settings.
4. When you are done you need to reconnect via Wifi and enter the new password.

## 7.2 Using the IRIScan™ App

---

The IRIScan™ app is a mobile application available for both iOS and Android. This app allows you to scan documents directly to your mobile device via the Scan Direct function, browse the files saved on the microSD card, transfer them to your mobile device, add or delete tags to those files, combine files into a multi-page PDF file, share files via your social media accounts.





1. Depending on the smart device you use, download the app from the Mac App Store (iOS) or Google Play (Android) and install it.
2. Enable the Wifi function on your smart device and connect to the **IRIScan™** network. See point 7 if necessary.  
When the connection is successful, "**Connected**" appears on-screen.
3. Start the IRIScan™ app.
4. Tap the list icon to access the menu.
  - **Dashboard:** here you can check the scanner's battery status, the Wifi connection status and the file uploading status.
  - **Scan Direct:** lets you scan documents directly to the app.
  - **File:** lets you browse the scans on the microSD card.

- **Tag:** here you configure the possible tags you can add to scans.
  - **Settings:** here you configure your social media accounts to which you can send scans.
  - **Info:** provides version info of the app.
5. Inside the menus, tap the list icon to return to the previous menu.

## 7.3 Resetting the Wifi Settings

---

### To reset the Wifi Settings to default:

1. Power on the scanner.
2. Press .
3. Press  until you reach **Reset Wifi**.
4. Press  **ENTER** to confirm.
5. Select **Yes**. Press  **ENTER** to confirm.  
"Reset in progress!" appears.  
When completed, "Reset completed!" appears.
6. Press  **BACK** to return to the top menus.

## 8. Troubleshooting

See the Troubleshooting section on [www.irislink.com/support](http://www.irislink.com/support).